

## 300W Configurable power supply.

Features	Benefits
• High Efficiency	Minimises heat in system
• Low Profile	Fits 1U Applications
• High Power Density	Requires less space
• Up To 5 Outputs	Eliminates need for additional supplies
• 3 Year Warranty	Low cost of ownership



Input			
Input Voltage	90-264Vac (below 100Vac input, derate by 3W / V)	Input Frequency	45 - 63Hz (440Hz with reduced PFC - consult sales office)
Input Harmonics	EN61000-3-2 compliant	Power Factor	0.97 typical
Input Fuse	6.3A Fast acting (not user accessible)	Inrush Current	15A typical at 25°C and 230Vac (cold start)
Earth Leakage Current	123µA at 120Vac (60Hz), 257µA max at 240Vac (60Hz) Worst case leakage current is less than 300µA at 264Vac, 63Hz (normal condition, 0.5mA Single Fault Condition)		

### How To Create A Product Description

**Number of outputs**  
(excluding standby and fan supplies)

↑

**Ch1 - Ch4** Letter/number from 'Available Outputs' table to represent output voltage

↑ ↑ ↑ ↑

**Global Option**

↑

**Case Option**

↑

**Blank** no case

- C U chassis + cover
- U U chassis
- F End fan + case<sub>1</sub>
- I IEC input, end fan + case<sub>1</sub>

**Blank** no option

- N3 5V/2A ATX compatible
- N4 12V/1A ATX compatible

1 - Needs '0H', '3H', '5H', 'TH' or 'FH' type channel 4. The fan speed is temperature dependent, ensuring optimum cooling and lowest audible noise

Confirm availability of created product with TDK-Lambda

### QUICK SELECTOR - example configurations

Model	Ch1	Ch2	Ch3	Ch4	Ch5	Global Option
NVA3-453TTH	5V / 40A	3.3V / 15A	12V / 5A	-12V / 2A	-	No
NVA3-453TTH-N3	5V / 40A	3.3V / 15A	12V / 5A	-12V / 2A	5V / 2A	ATX (-N3)
NVA3-350TTH	5V / 40A	-	12V / 5A	-12V / 2A	-	No
NVA3-350TTH-N3	5V / 40A	-	12V / 5A	-12V / 2A	5V / 2A	ATX (-N3)
NVA3-453FFH	5V / 40A	3.3V / 15A	15V / 5A	-15V / 2A	-	No
NVA3-453FFH-N3	5V / 40A	3.3V / 15A	15V / 5A	-15V / 2A	5V / 2A	ATX (-N3)
NVA3-350FFH	5V / 40A	-	15V / 5A	-15V / 2A	-	No
NVA3-350FFH-N3	5V / 40A	-	15V / 5A	-15V / 2A	5V / 2A	ATX (-N3)

## AVAILABLE OUTPUTS

Channel 1	Adjustment Range <sub>5</sub>	Channel 2 <sub>1</sub>	Adjustment Range <sub>5</sub>	Channel 3	Adjustment Range <sub>5</sub>	Channel 4 <sub>3</sub>	Adjustment Range		
<b>5</b>	5V / 40A <sub>2</sub>	5 - 5.5V	<b>1</b>	1.8V / 15A	0.9 - 2.5V				
			<b>2</b>	2.7V / 15A	2.5 - 3.8V				
			<b>3</b>	3.3V / 15A	2.5 - 3.8V				
			<b>2H</b>	2.7V / 24A	2.5 - 3.8V				
			<b>3H</b>	3.3V / 24A	2.5 - 3.8V				
			<b>0</b>	Omit					
<b>T</b>	12V / 25A	12 - 13V	<b>5</b>	5V / 10A	3.3 - 5.5V	<b>T</b>			
			<b>5H</b>	5V / 16A	3.3 - 5.5V				
			<b>0</b>	Omit					
			<b>0</b>	Omit					
<b>G</b>	24V / 12.5A	24 - 28V <sub>7</sub>	<b>5</b>	5V / 8A	5 - 5.5V	<b>TH</b>			
			<b>5H</b>	5V / 12.5A	5 - 5.5V				
			<b>T</b>	12V / 10A	12 - 15.5V				
			<b>F</b>	15V / 10A	12 - 15.5V				
			<b>0</b>	Omit					
			<b>0</b>	Omit					
				<b>T</b>	12V / 5A <sub>4</sub>	12 - 15V	<b>3H</b>	-3.3V / 2A <sub>8</sub>	Fixed
				<b>TH</b>	12V / 8A <sub>6</sub>	12 - 15V			
				<b>F</b>	15V / 4A <sub>4</sub>	12 - 15V			
				<b>FH</b>	15V / 6.4A <sub>6</sub>	12 - 15V			
				<b>G</b>	24V / 2.5A	18 - 24V			
				<b>0</b>	Omit				
							<b>5H</b>	-5V / 2A <sub>8</sub>	Fixed
							<b>TH</b>	-12V / 2A <sub>8</sub>	Fixed
							<b>FH</b>	-15V / 2A <sub>8</sub>	Fixed
							<b>0H</b>	Fan supply only	
							<b>0</b>	Omit	

- 1, 2, 3, 2H & 3H channel 2 only available with 5V channel 1.
- 5V / 10A channel 2 only available with 12 or 15V channel 1.
- 5V / 8A channel 2 only available with 24V channel 1.
- Maximum combined output current from Ch1 + Ch2 = 40A
- Follow output letters by 'P' for positive output channel 4.
- 60W max output power
- Max voltage at the output (includes remote sense)
- 96W max output power
- 24-24.5V if any channel 2 fitted
- 24 - 26V is 24V channel 3 fitted
- 1.5A max if fitted with '-F' option.

Other output options are available, please consult TDK-Lambda with your requirements

## Output Specification

Voltage / Current	See available outputs	
Turn on time	1.5s max	at 90Vac and 100% rated output power
Efficiency	up to 90%	configuration dependent
Hold up	16ms min	at 90Vac
Ripple and Noise	<1%	(or 50mV if higher) pk-pk, using EIAJ test method & 20MHz bandwidth 1.5% for units with 5V channel 1
Voltage Accuracy	±1%	±5% for Channel 4
Remote Sense	Yes	Channels 1 & 2. Max 0.5V total line drop
Minimum Load	No	on any output
Total Regulation	1.5%	For channels 1, 2 and 3 (2.5% for channel 4) Including Line (for 90-264Vac input change), Load (for 0-100% load change) and Cross (for 0-100% load change on any other output) regulation
Transient Response	<5%	of set voltage for 40% load change (in 50µs within the range 25-100% load)
Recovery	500µs	for recovery to 1% of set voltage
Over Voltage Protection	Yes	See Application Notes for details
Short Circuit Protection	Yes	
Over Temperature Protection	Yes	
Ch1 Good Signal	Yes	Provides a Logic 'Low' signal after Channel 1 output is within 90% (±5%) of nominal.
Output Power	300W	Total output power from all outputs for Vin above 180Vac, max output power = 300W + standby supply

## Isolation

Input to Output	Reinforced	2 x MOOPs (3rd edition 60601) 4.3kVdc
Input to Earth	Basic	2.3kVdc
Output to Earth		200Vdc

## Global Interface Signals - units fitted with N3 or N4 options

ATX Remote on/off	TTL high or open circuit will inhibit all outputs (except Standby)
ATX Power Good	Logic high indicates ac supply is good and output 1 is within regulation
Standby Supply	Common 0V with power supply. Not affected by ATX remote on/off -N3 Option = 5V / 2A -N4 Option = 12V / 1A

## Environment

Temperature	0°C to 50°C operational, -40°C to 70°C storage (max 12 months). Full load, with either '-F' option fitted or 1.5m/s air blown from input to output (approximately 10CFM)
Derating	50°C to 65°C derate each output by 2.5% per °C
Low Temp Startup	-20°C
Humidity	5 - 95% RH non condensing
Shock	±3 x 30g shocks in each plane, total 18 shocks 30g shock = 11ms (+/-0.5msec), half sine Conforms to EN60068-2-27, EN60068-2-47, IEC68-2-27, IEC68-2-47, JIS C0041-1987. Conforms to MIL-STD-810E/F, Method 516.5, Pro I, IV, VI
Vibration	Single axis 10 - 500 Hz at 2g (sweep and endurance at resonance) in all 3 planes Conforms to EN60068-2-6, IEC68-2-6 Conforms to MIL-STD-810E, Method 514.4, Pro I, Cat 1,9
Altitude	3000 metres operational
Pollution	Degree 2, Material group IIIb

## Immunity EN61000-6-2:2005, EN60601-1-2:2007

				Criteria
Electrostatic Discharge	EN61000-4-2	Level 4	Air discharge 15kV, Contact discharge 8kV. Not applicable to open frame units	A
Electromagnetic Field	EN61000-4-3	Level 3	12V/m	A
Fast / Burst Transient	EN61000-4-4	Level 4	ac input tested to 4.4kV dc output tested to 2.2kV	A
Surge Immunity	EN61000-4-5	Level 3	Common mode - 2.2kV, Differential - 1.1kV	A
Conducted RF Immunity	EN61000-4-6	Level 3	12V	A
Power Frequency Magnetic Field	EN61000-4-8	Level 4	30A/m	A
Voltage Dips, Variations, Interruptions	EN61000-4-11	Class 3	Criteria B for 5 sec interruption and dips to 40% for 5 cycles below 198Vac nominal input	A
Voltage Fluctuations	EN61000-4-14	Class 3	For 100 - 240V Nominal	A

## Emissions EN61000-6-3:2007, EN60601-1-2:2007

Radiated Electric Field	EN55011, EN55022	(as per CISPR.11/22) Class B, FCC47 part 15 subpart B see application note for details. Additional filtering required for IEC inlet version.
Conducted Emissions	EN55011, EN55022	(as per CISPR.11/22) Class B, FCC47 part 15 subpart B
Conducted Harmonics	EN61000-3-2	Class A
Flicker	EN61000-3-3	Compliant - $d_{max}$ only

## Approvals / Accreditations

IEC/EN 60950-1, UL60950-1 / CSA 22.2 No 60950-1	File E135494
IEC/EN 60601-1, UL/CSA 60601-1, ANSI/AAMI ES60601-1 CAN/CSA-C22.2 No 60601-1-08	File E349607
IEC/EN 61010-1	Designed to meet
CE Mark (EN60950-1)	LV Directive 2006/95/EC
CB certificate and Report available on request	<i>Please check with technical sales for status of approvals</i>
Designed and manufactured under the control of ISO9001 and ISO13485 (including risk management).	

## OUTLINE & CONNECTION DRAWINGS

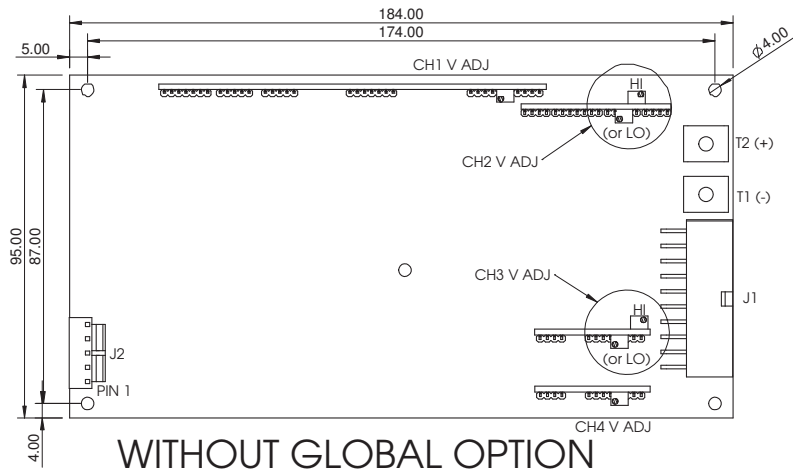

WITHOUT GLOBAL OPTION

J2

PIN	CONNECTION
1	EARTH
2	NOT CONNECTED
3	LIVE
4	NOT CONNECTED
5	NEUTRAL

J1

PIN	CONNECTION	PIN	CONNECTION
11	0V COMMON	1	0V COMMON
12	0V COMMON	2	0V COMMON
13	CH2 +Ve	3	CH2 +Ve
14	CH2 +Ve	4	CH2 +Ve
15	+SENSE CH1	5	-SENSE CH1
16	+SENSE CH2	6	-SENSE CH2
17	CH1 GOOD	7	N/C
18	CH3 +Ve	8	CH3 +Ve
19	0V COMMON	9	0V COMMON
20	CH4 O/P	10	CH4 O/P

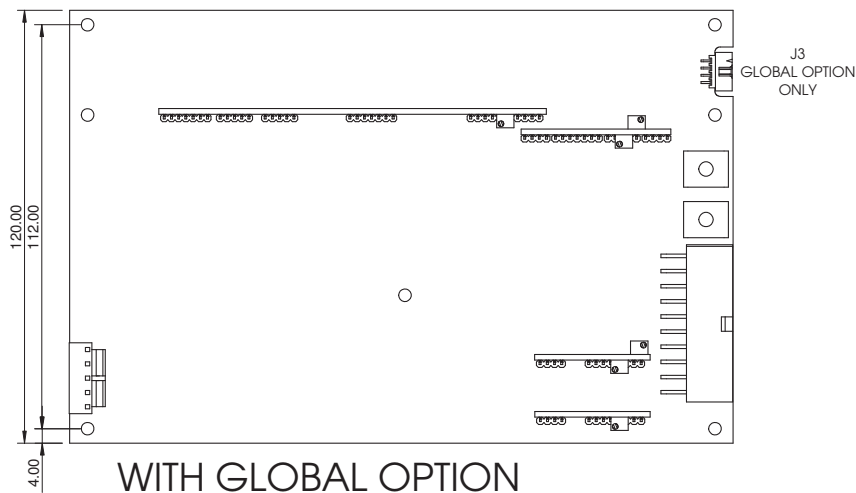

WITH GLOBAL OPTION

T1 & T2 (SEE TOP LEFT)

J3 (GLOBAL OPTION ONLY)

PIN	CONNECTION	PIN	CONNECTION
1	STANDBY -Ve	5	N/C
2	STANDBY +Ve	6	N/C
3	STANDBY -Ve	7	POWER GOOD
4	STANDBY +Ve	8	REM ON/OFF

MATING PARTS (MOLEX OR EQUIVALENT)

CONNECTOR	HOUSING	CRIMP PIN
J1	39-01-2205	44476-3112
J2	09-50-8051	08-52-0113
J3	51110-0860	50394
T1 & T2	N/A	TAG 19073-0165

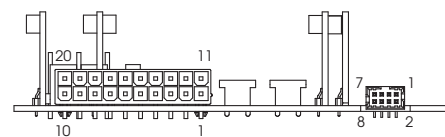
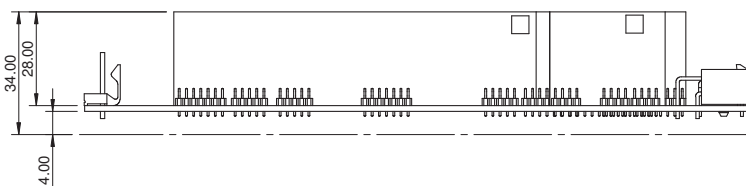

### Notes

1. All customer fixings are M3
2. Maximum thread penetration 4.5mm
3. Maximum torque 0.9Nm
4. All tolerances +/-0.5mm

Input and output connectors are not included with the product. They are available from TDK-Lambda

1 off input connector and 3 crimps part number is 94910.  
1 off output connector and 20 crimps part number is 94912.

## OUTLINE & CONNECTION DRAWINGS

OPEN FRAME

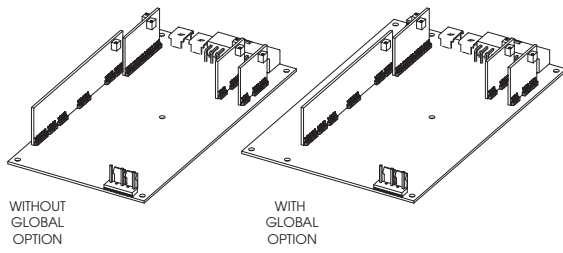

'U' CHASSIS  
(COVER OPTIONAL)

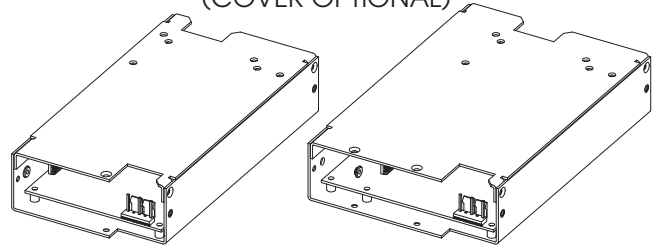

FAN OPTION

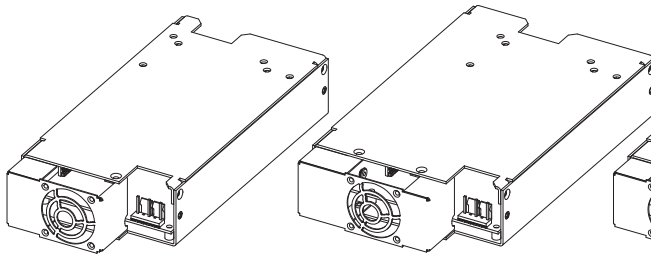

FAN+IEC OPTION

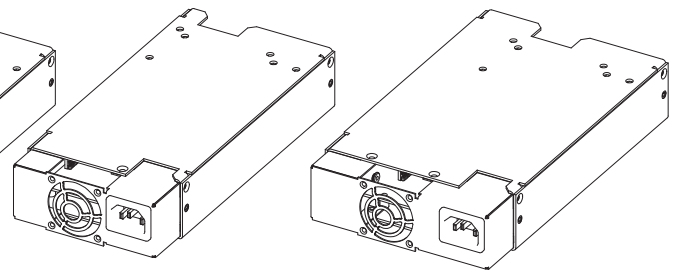

FAN+IEC OPTION

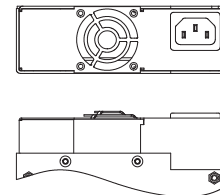
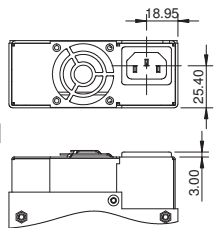

FAN OPTION

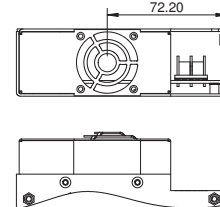
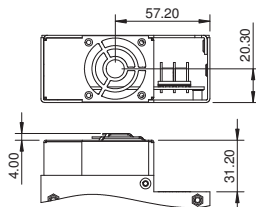

'U' CHANNEL

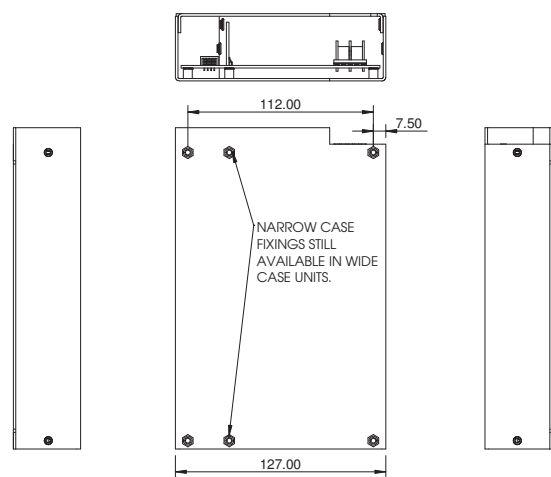
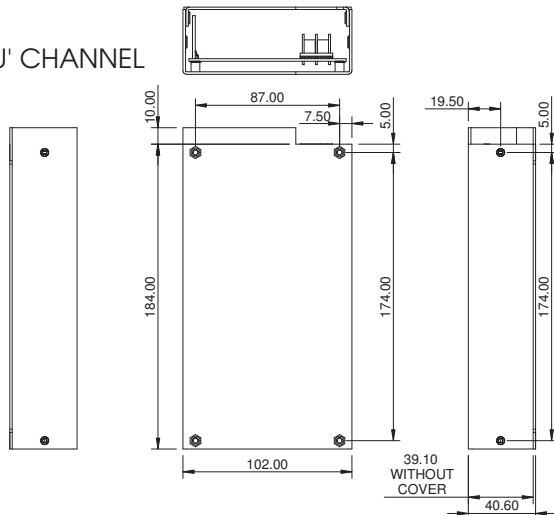

Notes

1. All customer fixings are M3
2. Maximum thread penetration 4.5mm
3. Maximum torque 0.9Nm
4. All tolerances +/-0.5mm



## TDK-Lambda France SAS

ZAC des Delaches  
CS 41077  
9 rue Thuillere  
91978 Villebon Courtaboeuf  
France  
Tel: +33 1 60 12 71 65  
Fax: +33 1 60 12 71 66  
france@fr.tdk-lambda.com  
www.fr.tdk-lambda.com



## Italy Sales Office

Via dei Lavoratori 128/130  
20092 Cinisello Balsamo (MI)  
Italy  
Tel: +39 02 61 29 38 63  
Fax: +39 02 61 29 09 00  
info.italia@it.tdk-lambda.com  
www.it.tdk-lambda.com



## Netherlands

info@tdk-lambda.nl  
www.tdk-lambda.nl



## TDK-Lambda Germany GmbH

Karl-Bold-Strasse 40  
77855 Achern  
Germany  
Tel: +49 7841 666 0  
Fax: +49 7841 5000  
info.germany@de.tdk-lambda.com  
www.de.tdk-lambda.com



## Austria Sales Office

Aredstrasse 22  
2544 Leobersdorf  
Austria  
Tel: +43 2256 655 84  
Fax: +43 2256 645 12  
info.germany@de.tdk-lambda.com  
www.de.tdk-lambda.com



## Scandinavia Sales Office

Valdemarsgade 7  
4100 Ringsted  
Denmark  
Tel: +45 24 63 95 65  
Fax: +45 69 80 44 99  
info@de.tdk-lambda.com  
www.emea.tdk-lambda.com



## Switzerland Sales Office

Bahnhofstrasse 50  
8305 Dietlikon  
Switzerland  
Tel: +41 44 850 53 53  
Fax: +41 44 850 53 50  
info@de.tdk-lambda.com  
www.de.tdk-lambda.com

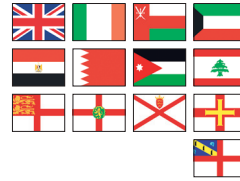

## TDK-Lambda UK Ltd.

Kingsley Avenue  
Ilfracombe  
Devon EX34 8ES  
United Kingdom  
Tel: +44 (0) 12 71 85 66 66  
Fax: +44 (0) 12 71 86 48 94  
powersolutions@uk.tdk-lambda.com  
www.uk.tdk-lambda.com



## TDK-Lambda Ltd.

Kibbutz  
Givat Hashlosha 48800  
Israel  
Tel: +9 723 902 4333  
Fax: +9 723 902 4777  
info@tdk-lambda.co.il  
www.tdk-lambda.co.il



## C.I.S.

**Commercial Support:**  
Tel: +7 (495) 665 2627  
**Technical Support:**  
Tel: +7 (812) 658 0463  
info@tdk-lambda.ru  
www.tdk-lambda.ru

## Local Distribution