

HWS 15A-150A Series

Instruction Manual

BEFORE USING THE POWER SUPPLY UNIT

Be sure to read this instruction manual thoroughly before using this product. Pay attention to all cautions and warnings before using this product. Incorrect usage could lead to an electrical shock, damage to the unit or a fire hazard.

DANGER

Never use this product in locations where flammable gas or ignitable substances are present. There are risks of igniting these substances and exploding by an arcing.

WARNING

- Do not touch this product or its internal components while circuit is live, or shortly after shutdown. There may be high voltage or high temperature present and you may receive an electric shock or burn.
- While this product is operating, keep your hands and face away from it as you may be injured by an unexpected situation.
- Do not make unauthorized changes to this product, otherwise you may receive an electric shock and void your warranty.
- Do not drop or insert anything into this product. It might cause a failure, fire and electric shock.
- Do not use this product under unusual condition such as emission of smoke or abnormal smell and sound etc. It might lead to fire and electric shock. In such cases, please contact us. Do not attempt repair by yourself, as it is dangerous for the user.
- Do not operate these products in the presence of condensation. It might lead fire and electric shock.

CAUTION

- This power supply is designed and manufactured for use within an end product such that it is accessible to SERVICE ENGINEERS only.
- Confirm connections to input/output terminals and signal terminal are correct as indicated in the instruction manual before switching on.
- Input voltage, Output current, Output power, ambient temperature and ambient humidity should be kept within specifications, otherwise the product will be damaged.
- Do not operate and store this product in an environment where condensation might occur. In such case, waterproof treatment is necessary.
- Do not use this product in environment with a strong electromagnetic field, corrosive gas or conductive substances.
- For applications, which require very high reliability (Nuclear related equipment, medical equipment, traffic control equipment, etc.), it is necessary to provide a fail-safe mechanism in the end equipment.
- Do not inject abnormal voltages into the output or signal of this product. The injection of reverse voltage or over voltage exceeding nominal output voltage into the output or signal terminals might cause damage to internal components.
- Never operate the product under over current or short-circuit conditions, or outside its specified Input Voltage Range. Insulation failure, smoking, burning or other damage may occur.
- This product contains a printed circuit board utilizing surface mounted devices. PCB stress such as bending, twisting etc. could cause damage. Therefore, please handle with care.
- This power supply has possibility that hazardous voltage may occur in output terminal depending on failure mode. The output of these products must be protected in the end use equipment to maintain SELV.
- The information in this document is subject to change without prior notice. Please refer to the latest version of the data sheet, etc., for the most up-to date specifications of the product.
- No part of this document may be copied or reproduced in any form without prior written consent of TDK-Lambda.

Note : CE MARKING

CE Marking when applied to a product covered by this handbook indicates compliance with the low voltage directive (2006/95/EC) in that it complies with EN60950-1.

1. Model name identification method

HWS 15A - 5 / □

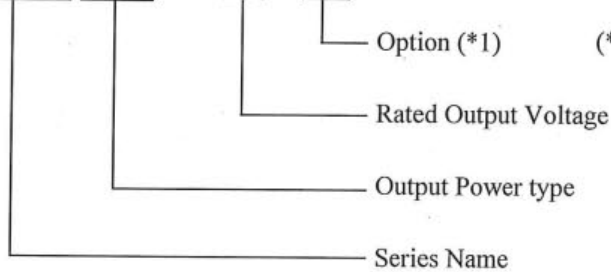

(*1) Blank : Open frame type. (Standard)

/A : With cover type.

/R : Open frame type with remote ON/OFF control model. (*2)

/RA : Remote ON/OFF control, with cover. (*2)

/ADIN : DIN rail mountable

(Only cover type of 24V)

(*2) Option of HWS50A, 100A, 150A

2. Terminal Explanation

HWS15A, HWS30A, HWS50A

- ① +V : + Output terminal (15A max. / terminal)
- ② -V : - Output terminal (15A max. / terminal)
- ③ FG : Frame Ground
- ④ L : Input terminal Live line (Fuse in line)
- ⑤ N : Input terminal Neutral line
- ⑥ Output voltage adjustment trimmer
- ⑦ Output monitoring indicator (Green LED)

*All screws size is M3.5

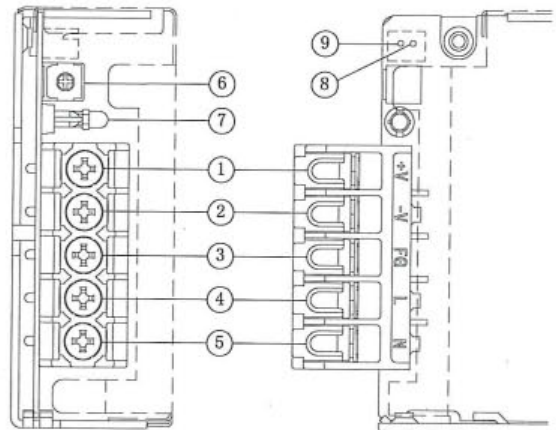

HWS50A/R (Include /RA)

- ⑧ -R : Remote ON/OFF control
- ⑨ +R : Remote ON/OFF control

* Connector (JST) for Remote ON/OFF control

Connector	Housing	Terminal Pin
B2B-XH-AM	XHP-2	BXH-001T-P0.6 or SXH-001T-P0.6

Hand Crimping Tool : YC-110R (JST) or YRS-110 (JST)

Use recommended crimping tool.

Matching housing and terminal pin --- Not included with the product.

HWS100A, HWS150A

- ① +V : + Output terminal (30A max. / terminal)
- ② -V : - Output terminal (30A max. / terminal)
- ③ FG : Frame Ground
- ④ L : Input terminal Live line(Fuse in line)
- ⑤ N : Input terminal Neutral line
- ⑥ +S : + Remote sensing terminal
- ⑦ -S : - Remote sensing terminal
- ⑧ Output voltage adjustment trimmer
- ⑨ Output monitoring indicator (Green LED)

*All screws size is M3.5

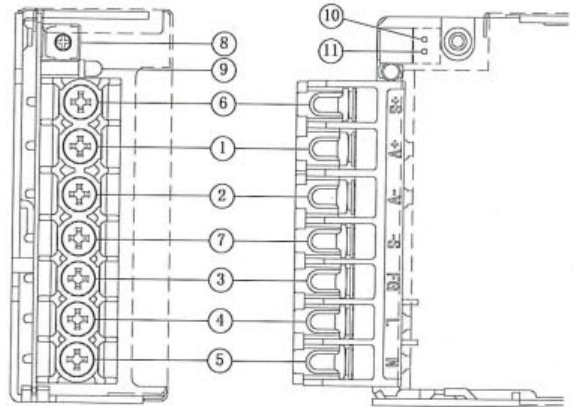

HWS100A/R*, HWS150A/R (Include / RA)

- ⑩ -R : Remote ON/OFF control
- ⑪ +R : Remote ON/OFF control

* Connector (JST) for Remote ON/OFF control

Connector	Housing	Terminal Pin
B2B-XH-AM	XHP-2	BXH-001T-P0.6 or SXH-001T-P0.6

Hand Crimping Tool : YC-110R (JST) or YRS-110 (JST)

Use recommended crimping tool.

Matching housing and terminal pin --- Not included with the product.

3. Connecting method

Pay attention to the input wiring. If it is connected to wrong terminal, the power supply will be damaged.

- Input must be off when making connections.
- Connect FG terminal to earth (frame ground of the equipment etc.) by thick wire for safety and improvement of noise sensitivity.

HWS15A, HWS30A, HWS50A

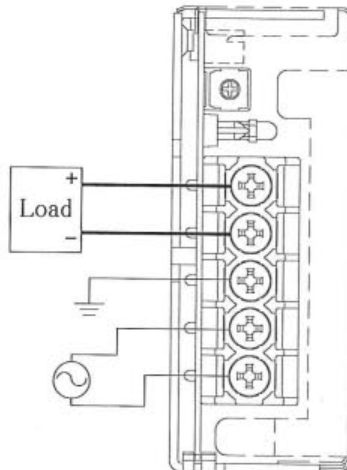

HWS100A, HWS150A

• Basic connection (Local sensing)

Connect “+S” terminal to “+V” terminal, and “-S” terminal to “-V” terminal with the attached short pieces .
 (Short pieces are mounted at time of shipment.)

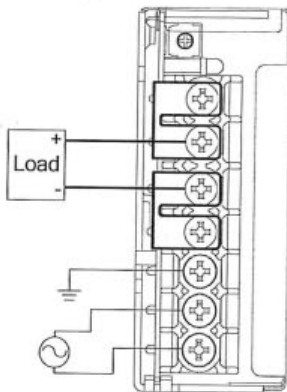

• Remote sensing connection

Connect “+S” terminal to “+” terminal of load, and “-S” terminal to “-” terminal of load with wires.
 If remote sensing terminals are opened, the output will rise and OVP may be triggered.

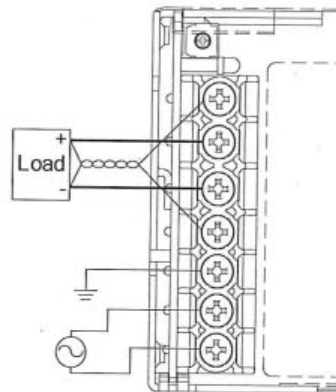

Recommended torque : HWS15A ~ HWS150A M3.5 screw 1.0N·m(10.2kgf·cm) ~ 1.6N·m(16.3kgf·cm)

4. Explanation of Functions and Precautions

4-1. Input Voltage Range

Input voltage range is single phase 85-265VAC(47-63Hz) or 120-370VDC. Input voltage, which is out of specification, might lead unit damage. For cases where conformance to various safeties required, described as 100-240VAC (50-60Hz).

Note : HWS-A series is able to withstand input of 300VAC for 5 seconds (No damage). Please note that to satisfy the electrical characteristics, the input voltage range must be within 85-265VAC.

4-2. Output Voltage Range

Output voltage is set the rated value at shipment. V.ADJ trimmer can adjust the output voltage within the range.

Output voltage range is within +/- 20% (3.3V : +20%/-10%, 48V : +10%/-20%) of nominal output voltage.

To turn the trimmer clockwise, the output voltage will be increased. Take note when the output voltage is increased excessively, over voltage protection (OVP) function may trigger and voltage will be shut down. Furthermore, when increasing the output voltage reduce the output current so as not to exceed the maximum output power.

4-3. Inrush Current

This series equipped Power thermistor to limit the inrush current. This series are Power thermistor method so that higher current will flow at higher ambient temperature or re-input condition. Please select input switch and fuse carefully with the high temperature and re-input the power condition. The inrush current value is under cold start at 25°C in the specification.

4-4. Over Voltage Protection (OVP)

The OVP function (Inverter shut down method, manual reset type) is provided. OVP function operates within 3.3V: 125% - 150%, 5-24V: 125% - 145%, 48V: 115%-135% of nominal output voltage.

When OVP triggers, the output will be shut down. To reset OVP, remove the input of power supply for a few minutes, and then re-input. In addition, the setting value of OVP is fixed and not adjustable. Pay attention not to apply higher voltage externally to the output terminal to avoid unit failure. In case of inductive load, put protective diode in series to the output power line.

4-5. Over Current Protection (OCP)

HWS15A, HWS30A, HWS50A : Fold back limit and Hiccup mode with automatic recovery.

HWS100A, HWS150A : Constant current limit and Hiccup with automatic recovery.

OCP function operates when the output current exceeds 105% of maximum DC output current of specification.

The outputs will be automatically recovered when the overload condition is canceled. Never operate the unit under over current or shorted conditions, which may leads damage. OCP setting is fixed and not to be adjusted externally.

4-6. Remote Sensing (+S, -S terminal)

(For HWS100A, HWS150A)

This function compensates voltage drop of wiring from output terminals to load terminals. Connect "+S" terminal to "+" terminal of load and "-S" terminal to "-" terminal of load with sensing wires.

The total line voltage drop (+ side line and - side line) shall be less than 0.3V.

In case that sensing line is too long, it is necessary to put an electrolytic capacitor in following 3 placed;

- 1) Across the load terminal,
- 2) Between "+S" terminal and "+V" terminal,
- 3) Between "-S" terminal and "-V" terminal.

If remote sensing terminals are opened, the output will rise and OVP may be triggered.

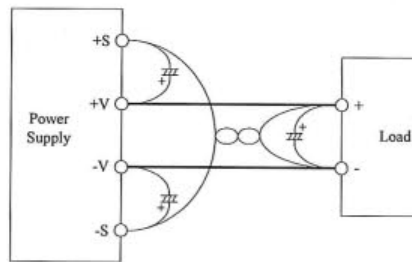

4-7. Output Ripple & Noise

The standard specification for maximum ripple value is measured according to measurement circuit specified by JEITA RC-9131B. When load lines are longer, ripple will becomes larger. In this case, electrolytic capacitor, film capacitor, etc. might be necessary to use across the load terminal.

The output ripple cannot be measure accurately if the probe ground lead of oscilloscope is too long.

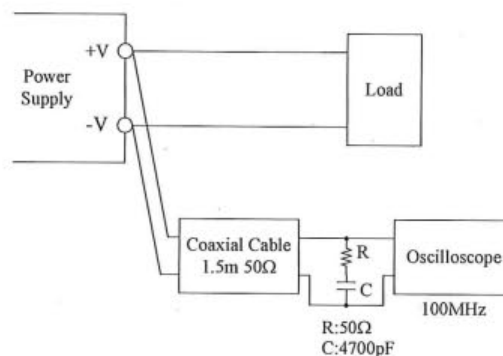

4-8. Series Operation

For series operation, either method (A) or (B) is possible.

Method (A)

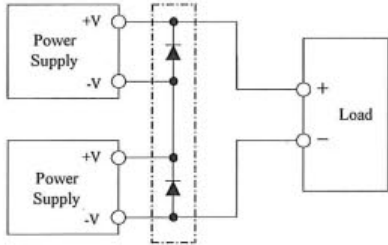

Method (B)

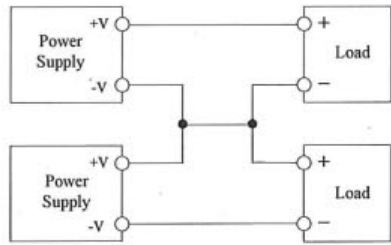

Note : In case of (A), please connect bypass diodes to prevent reverse voltage.
 Please select a bypass diode with maximum forward current rating more than output load current.
 And maximum reverses voltage must withstand each power supply output voltage.
 *Serie operation for HWS100A,HWS150A possible without bypass diode.
 Never use when one of the unit not operate, which may leads damage.

4-9. Parallel Operation

- (A) Operation to increase the Output Current is not possible.
- (B) Operation as a Backup Power Supply is possible as follows.
 1. Set the power supply output voltage higher by the amount of forward voltage drop (VF) of the diode.
 2. Please adjust the output voltage of each power supply to be the same.
 3. Please use within the specifications for output voltage and output power.
 4. Please select a reverse current prevention diode with maximum forward current rating more than output load current.

(A)

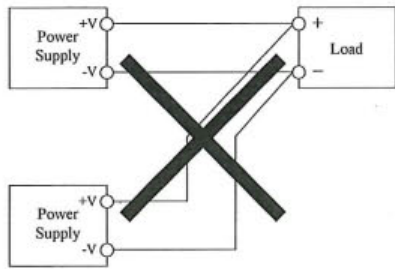

(B)

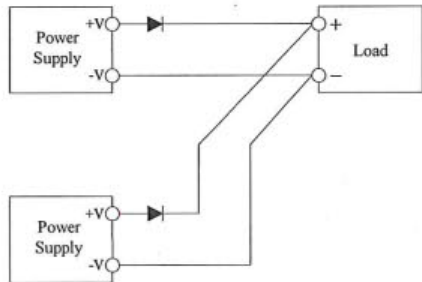

4-10. Isolation Test

Isolation resistance between Output – FG terminal is more than 100MΩ at 500VDC. For safety operation, voltage setting of DC isolation tester must be done before the test. Ensure that the unit is fully discharged after the test.

■ Output – FG terminal : 500VDC More than 100MΩ

(A) HWS15A,HWS30A

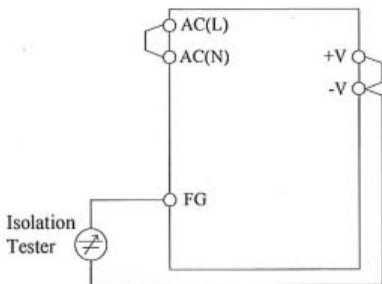

(B) HWS50A

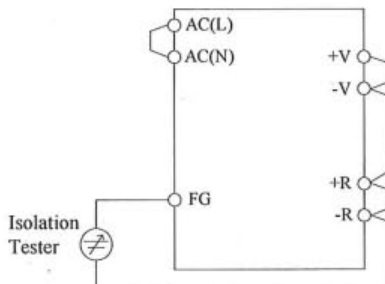

(C) HWS100A,HWS150A

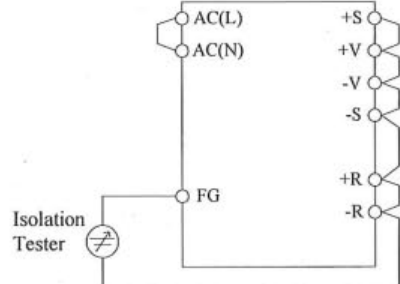

4-11. Withstand Voltage

This series is designed to withstand 3.0kVAC between input and output, 2.0kVAC between input and FG and 500VAC between output and FG each for 1 minute. When testing withstand voltage, set current limit of withstand voltage test equipment at 20mA. The applied voltage must be gradually increased from zero to testing value and then gradually decreased for shut down. When timer is used, the power supply may be damaged by high impulse voltage at timer switch on and off. Connect input and output as follows.

- Input ~ FG (solid line) : 2.0kVAC, 1min (20mA)
- Input ~ Output (dotted line) : 3.0kVAC, 1min (20mA)

(A) HWS15A,HWS30A

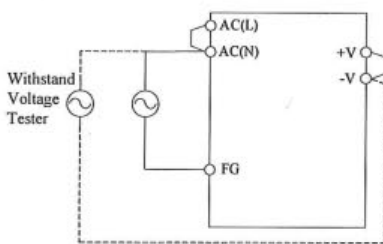

(B) HWS50A

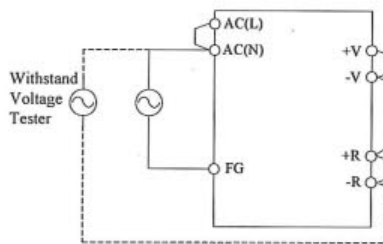

(C) HWS100A,HWS150A

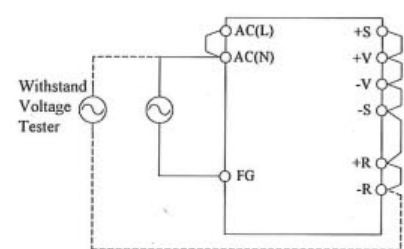

- Output ~ FG : 500VAC, 1min (20mA)

(A) HWS15A,HWS30A

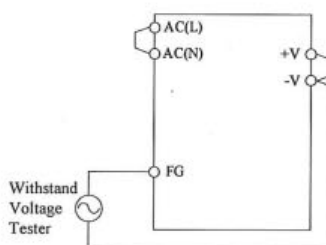

(B) HWS50A

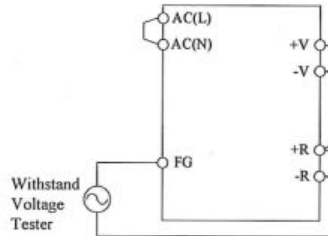

(C) HWS100A,HWS150A

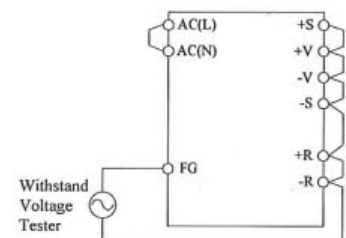

4-12. Remote ON/OFF Control (HWS50A-150A Option)

Remote ON/OFF control function is available as option with model name followed by /R.
 Using this function allows the user to turn the output on and off without having to turn the AC input off and on.
 It is controlled by the voltage applied to +R and -R. This circuit is in the Secondary side of the power supply unit.
 Do not connect in the primary side of power supply unit.
 And this circuit is isolated from the output of power supply unit.

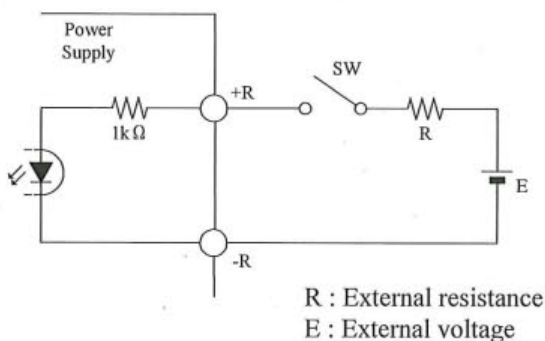

The control mode is shown below.

+R & -R terminal condition	Output condition
SW ON (Higher than 4.5V)	ON
SW OFF (Lower than 0.8V)	OFF

External voltage : E	External resistance : R
4.5 ~ 12.5VDC	No required
12.5 ~ 24.5VDC	1.5kΩ

5. Mounting Method

5-1. Mounting Method

- (1) This is convection cooling type power supply. In the consideration for the heat radiation and safety. Please take a distance more than 15mm between the power supply and the peripheral parts. When lining up multiple units, please make sure to place them 15mm or more apart from each other.
- (2) Please take insulation distance (space) more than 5mm for the component side at the open frame type.
- (3) The maximum allowable penetration of mounting screws is 6mm.
- (4) Recommended torque for mounting screw
 HWS15A-150A (M3 screw) : 0.49 N·m (5.0 kgf·cm)

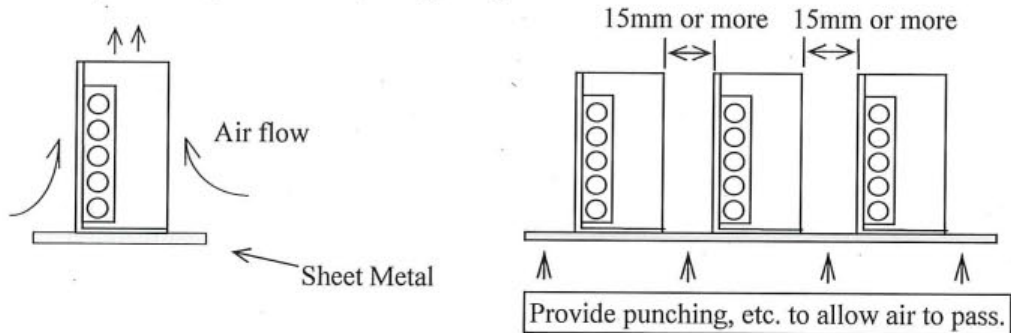

5-2. Output Derating according to the Mounting Directions

Recommend standard mounting is direction (A). Direction (B), (C) and (D) are also possible. For other mounting directions, please inquire to TDK-Lambda.

Refer to the derating below. Please do not use mounting direction (E), where the PCB will be on the topside and heat will be trapped inside the unit. Load (%) is percent of maximum output power or maximum output current, do not exceed its derating of maximum load.

■ Mounting direction

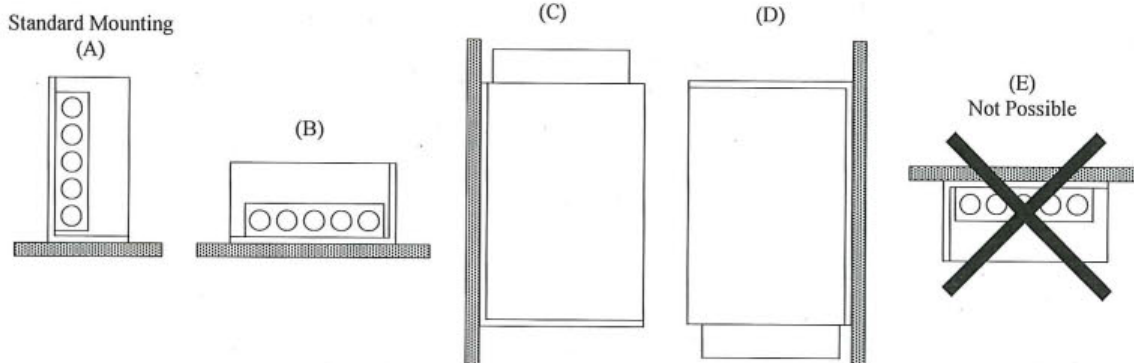

Output Derating

HWS15A

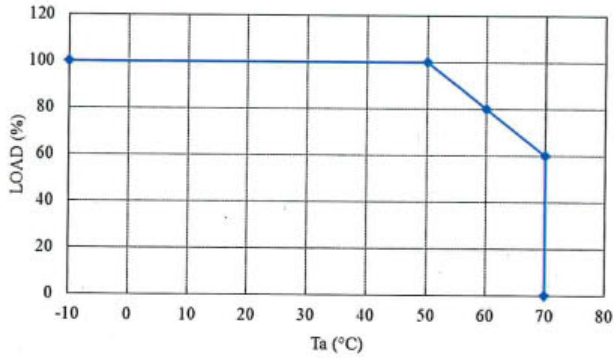

◆ Mounting (A),(B),(C),(D)

Ta (°C)	Load (%)	
	Mounting (A),(B),(C),(D)	
-10 ~ +50	100	
60	80	
70	60	

HWS30A

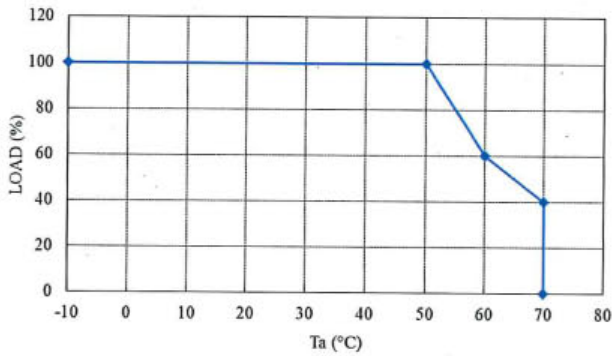

◆ Mounting (A),(B),(C),(D)

Ta (°C)	Load (%)	
	Mounting (A),(B),(C),(D)	
-10 ~ +50	100	
60	60	
70	40	

HWS50A

(Include option model / R)

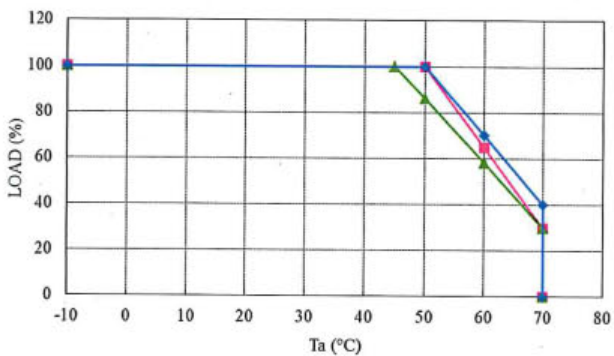

◆ Mounting (A)
■ Mounting (B),(D)
▲ Mounting (C)

Ta (°C)	Load (%)		
	Mounting (A)	Mounting (B),(D)	Mounting (C)
-10 ~ +45	100	100	100
50	100	100	86
60	70	65	58
70	40	30	30

HWS100A

(Include option model / R)

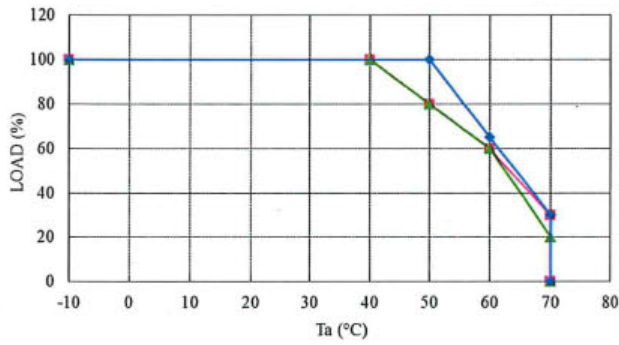

- ◆ Mounting (A)
- Mounting (B)
- ▲ Mounting (C),(D)

Ta (°C)	Load (%)		
	Mounting (A)	Mounting (B)	Mounting (C),(D)
-10 ~ +40	100	100	100
50	100	80	80
60	65	60	60
70	30	30	20

HWS150A

(Include option model / R)

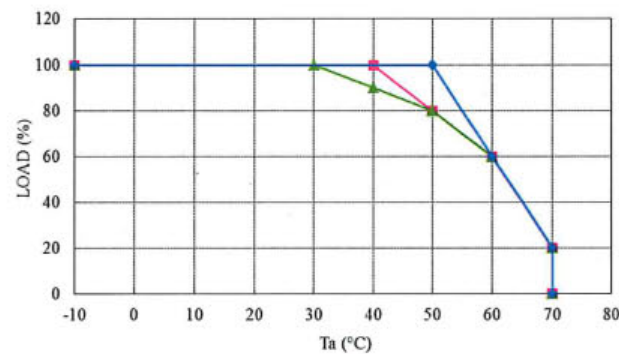

- ◆ Mounting (A)
- Mounting (B)
- ▲ Mounting (C),(D)

Ta (°C)	Load (%)		
	Mounting (A)	Mounting (B)	Mounting (C),(D)
-10 ~ +30	100	100	100
40	100	100	90
50	100	80	80
60	60	60	60
70	20	20	20

HWS15A/A (With cover type)

(Include option model / ADIN)

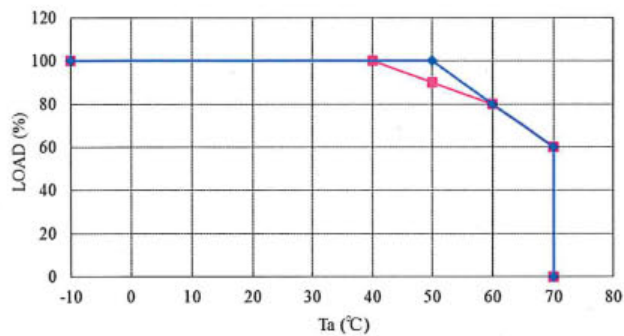

- ◆ Mounting (A)
- Mounting (B),(C),(D)

Ta (°C)	Load (%)	
	Mounting (A)	Mounting (B),(C),(D)
-10 ~ +40	100	100
50	100	90
60	80	80
70	60	60

HWS30A/A (With cover type)
(Include option model / ADIN)

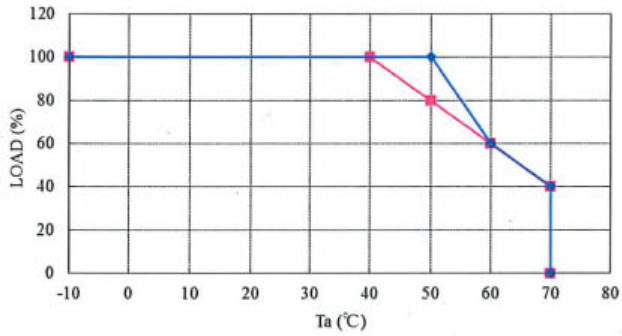

◆ Mounting (A)
 ■ Mounting (B),(C),(D)

Ta (°C)	Load (%)	
	Mounting (A)	Mounting (B),(C),(D)
-10 ~ +40	100	100
50	100	80
60	60	60
70	40	40

HWS50A/A (With cover type)
(Include option model / RA, / ADIN)

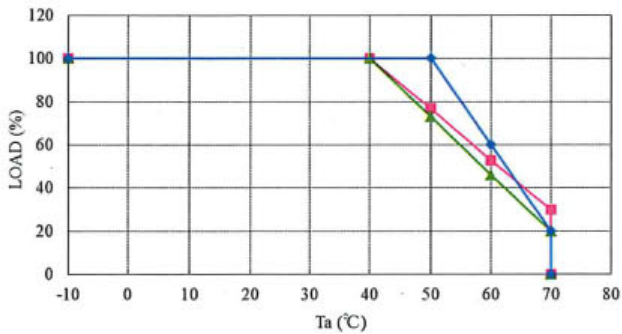

◆ Mounting (A)
 ■ Mounting (B),(D)
 ▲ Mounting (C)

Ta (°C)	Load (%)		
	Mounting (A)	Mounting (B),(D)	Mounting (C)
-10 ~ +40	100	100	100
50	100	76	73
60	60	53	46
70	20	30	20

HWS100A/A (With cover type)
(Include option model / RA, / ADIN)

*Refer to dotted line for output derating curve, when input voltage range is "85VAC ≤ Vin < 90VAC" for the Mounting (A).

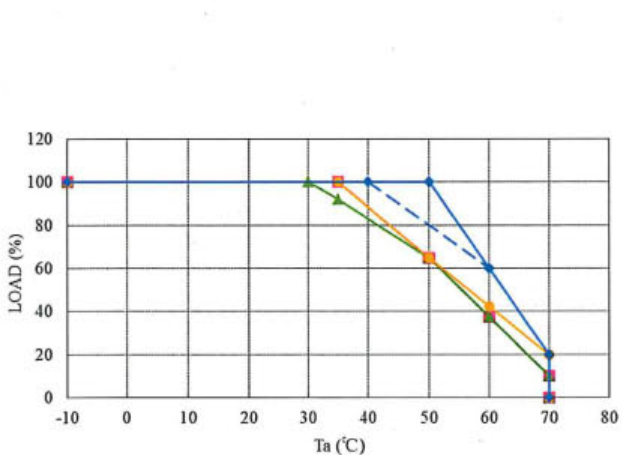

◆ Mounting (A)
 ■ Mounting (B)
 ▲ Mounting (C)
 ● Mounting (D)

Ta (°C)	Load (%)			
	Mounting (A)	Mounting (B)	Mounting (C)	Mounting (D)
-10 ~ +30	100	100	100	100
35	100	100	92	100
50	100	65	65	65
60	60	37	37	42
70	20	10	10	20

HWS150A/A (With cover type)

(Include option model / RA, / ADIN)

*Refer to dotted line for output derating curve, when input voltage range is "85VAC ≤ Vin < 90VAC" for the Mounting (A).

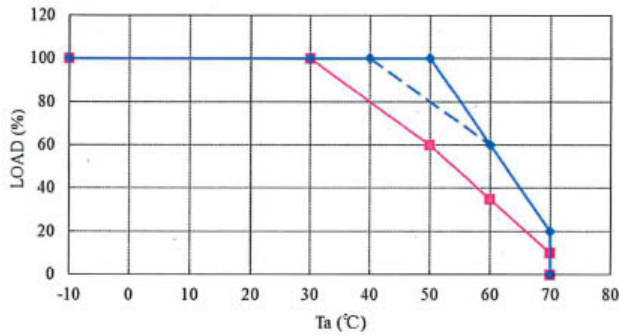

◆ Mounting (A)
 ■ Mounting (B),(C),(D)

Ta (°C)	Load (%)	
	Mounting (A)	Mounting (B),(C),(D)
-10 ~ +30	100	100
50	100	60
60	60	35
70	20	10

6. Wiring Method

- (1) The output load line and input line shall be separated, and use all lines as thick and short as possible to make lower impedance. The output load line and input line shall be twisted or use shielded wire to improve noise sensitivity.
- (2) Remote sensing lines and remote ON/OFF control lines shall be twisted or use shielded wire, and separated from the output lines.
- (3) Noise can be eliminated by attaching a capacitor to the load terminals.
- (4) The recommended wire type, torque and crimp-type terminal :

MODEL	Recommended Wire	Recommended torque	Recommended crimp-type terminal		
			D (MAX)	t (MAX)	Mounting pieces (MAX)
HWS15A-50A	AWG14-22	All terminal M3.5 Screws 1.0N·m (10.2kgf·cm)~1.6N·m (16.3kgf·cm)	6.8mm	0.8mm	2 piece
HWS100A	AWG12-22	Output terminal M3.5 Screws 1.0N·m (10.2kgf·cm)~1.6N·m (16.3kgf·cm)	8.1mm	1.0mm	1 piece
	AWG14-22	Other terminal M3.5 Screws 1.0N·m (10.2kgf·cm)~1.6N·m (16.3kgf·cm)		0.8mm	2 piece
HWS150A	AWG10-22	Output terminal M3.5 Screws 1.0N·m (10.2kgf·cm)~1.6N·m (16.3kgf·cm)	8.1mm	1.0mm	1 piece
	AWG14-22	Other terminal M3.5 Screws 1.0N·m (10.2kgf·cm)~1.6N·m (16.3kgf·cm)		0.8mm	2 piece

Note 1 : When using separate loads, use of two pcs. of 0.8mm thick crimp-type terminal is recommended.

Note 2 : For recommended diameter, refer to wire maker recommended allowable current and voltage drop.

Especially, for 3V or 5V models, output current is large. Thick diameter wire is recommended.

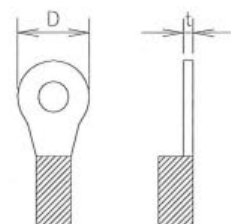

7. The life expectancy

The life expectancy of the power supply is as follows.

The life of the power supply depends on the life of the built-in aluminum electrolytic capacitor.

The life expectancy is not a guaranteed value, please consider as a reference.

Please do not use the product which passed over the life expectancy.

There is a risk of unexpected output shutdown and specifications may not be satisfied.

Please contact us for maintenance or exchange the product which passed over the life expectancy.

The life expectancy of power supply is calculated in condition of rated input voltage and 24-hour continuous operation.

Load (%) is percent of maximum output power or maximum output current, do not exceed its derating of maximum load.

◇HWS15A, HWS30A

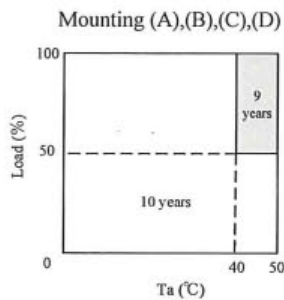

◇HWS15A/A, HWS30A/A

(With cover type)

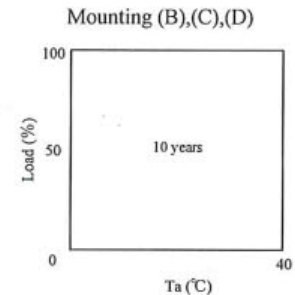
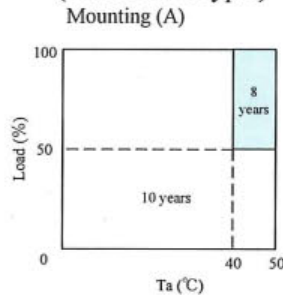

◇HWS50A

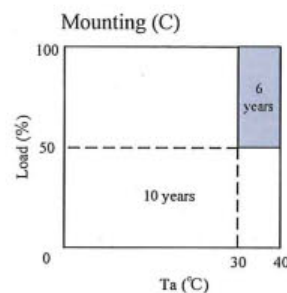
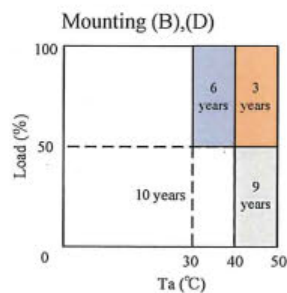
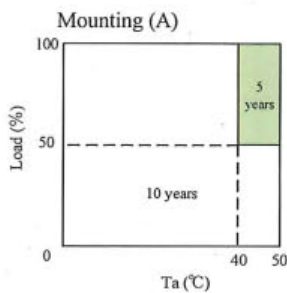

◇HWS50A/A

(With cover type)

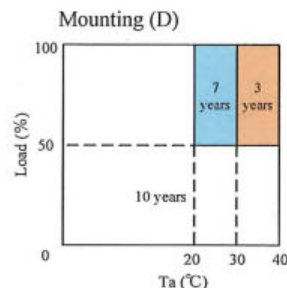
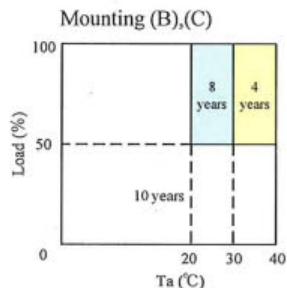
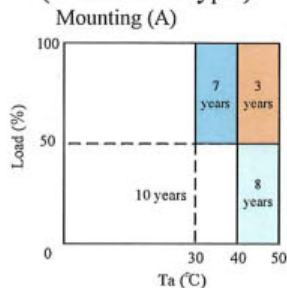

◇ **HWS100A**

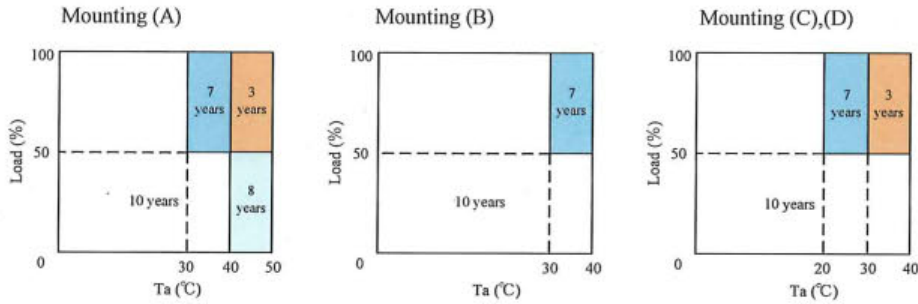

◇ **HWS100A/A**
 (With cover type)

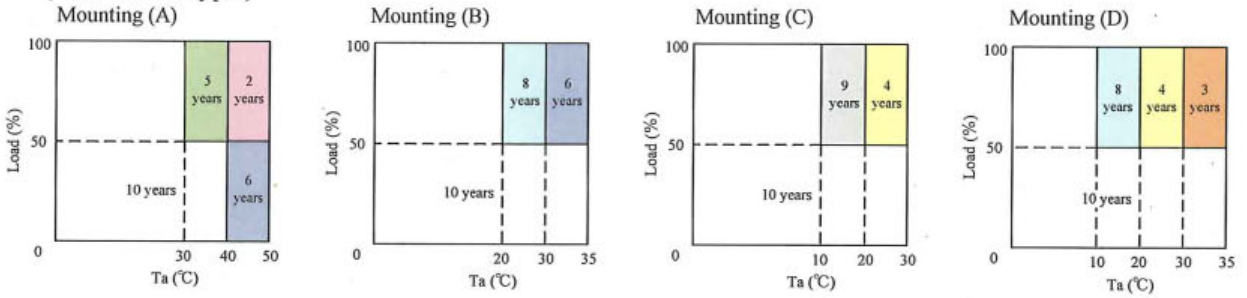

◇ **HWS150A**

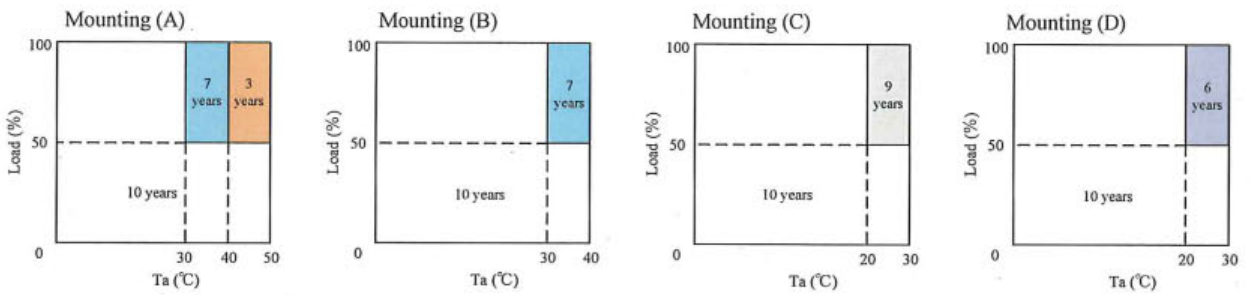

◇ **HWS150A/A**
 (With cover type)

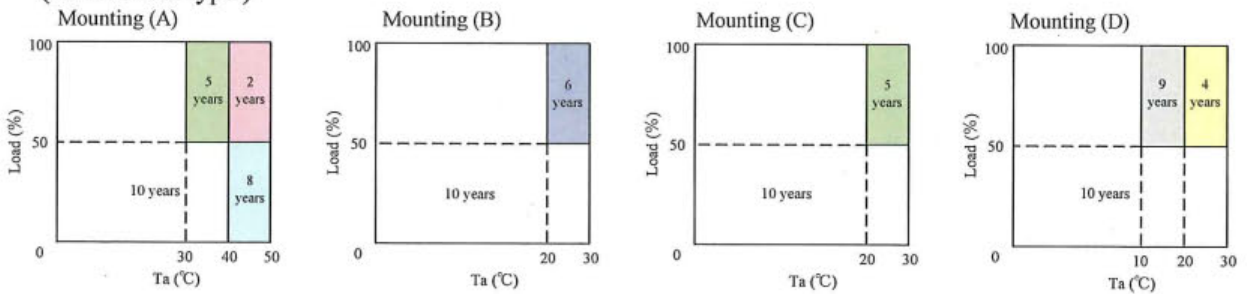

8. External Fuse Rating

Refer to the following fuse rating when selecting the external input fuse.

Surge current flows when input turn on. Use slow-blow fuse or time-lug fuse. Fast-blow fuse can not be used.

Fuse rating is specified by inrush current value at input turn on.

Do not select the fuse according to actual input current (rms.) values.

HWS15A	: 2A
HWS30A-100A	: 3.15A
HWS150A	: 5A

9. Before concluding that the unit is at fault...

Before concluding that the unit is at fault, make the following checks.

- (1) Check if the rated input voltage is connected.
- (2) Check if the wiring of input and output is correct.
- (3) Check if the wire size is not too thin.
- (4) Check if the output voltage control (V.ADJ) is properly adjusted.
- (5) Check if the Remote ON/OFF control connector is not opened, when use Remote ON/OFF control function.
- (6) Check if the output current and output power does not over specification.
- (7) Audible noise can be heard when input voltage waveform is not sinusoidal wave.
- (8) Audible noise can be heard during Dynamic-Load operation.
- (9) Ensure that a large capacitor is not connected on the output side.

Please use within maximum capacitance shown below.

If connecting more than the following capacity, conditioning is needed. Please contact us for details.

MODEL	Maximum external capacitance					
	3.3V	5V	12V	15V	24V	48V
HWS15A	10,000uF		5,000uF	2,000uF	1,000uF	500uF
HWS30A,HWS50A	10,000uF		5,000uF		2,000uF	500uF
HWS100A,HWS150A	10,000uF				5,000uF	1,000uF